

GENERAL DESCRIPTION

This product is a resettable fire emergency call point compatible with control panels implementing the Vega intelligent protocol. After use, the alarm activating button can be restored with the supplied key and made ready for immediate reutilization.

HFI-CP-WP-03 is composed by a back box, an intelligent loop interface plate and a front manual activation element.

IMPORTANT INSTALLATION NOTES

- *The location of call points must follow recognised national or international application codes of practice.*
- *This product is to be used in conjunction with compatible control panels employing the Vega protocol.*
- *Connections to loop terminals are polarity sensitive: check them by referring to the wiring instructions contained in this manual.*
- *Disconnect the loop from the control panel during installation.*
- *Reconnect the loop to the control panel after installation completion.*
- *Test the device to check that it actually works.*
- *Take care that every single device on the loop is programmed with a unique address.*

INSTALLATION

1. Program a unique analogue address into the loop's interface plate belonging to the call point.
2. Record on the device's appropriate label the loop number and device address.
3. Fix the back box using the 2 provided screws: insert them in the diagonally opposite screw holes.
4. Use suitable IP rated cable glands (not supplied). Install the cable conduit plus gland into the back box entry hole.
5. Feed the loop's cables into the back box's inner space; allow sufficient length so you can perform loop wiring comfortably.
6. If present, connect the loop's shield wires to the terminal block in the back box's inner space.
7. Connect the loop's cables to the call point's interface plate.
8. Position the interface plate onto the back box; its locking hooks must be positioned on the bottom side.
9. Fix the interface plate to the back box using the supplied screws.
10. Hook the upper rear side of the front activation element onto the interface plate.
11. Push the bottom of the activation element; this will lock it together with the interface plate.

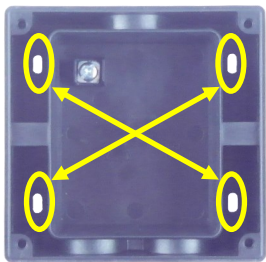

Pic. 1 - Fix the back box using the screw holes highlighted.

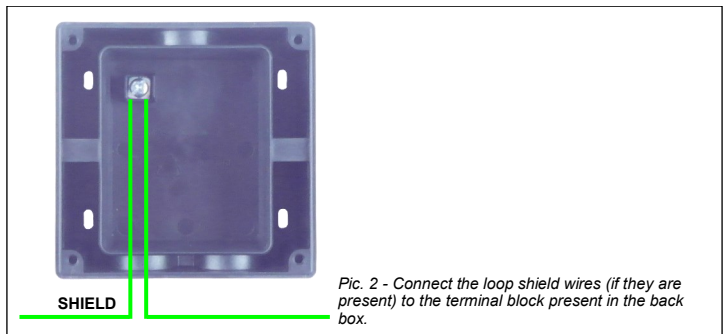

Pic. 2 - Connect the loop shield wires (if they are present) to the terminal block present in the back box.

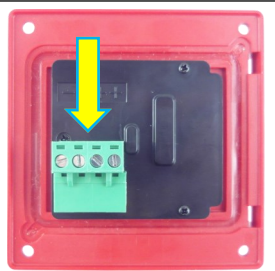

Pic. 3 - Insert the supplied pluggable terminal block connector to the socket positioned on the back of the loop interface plate.

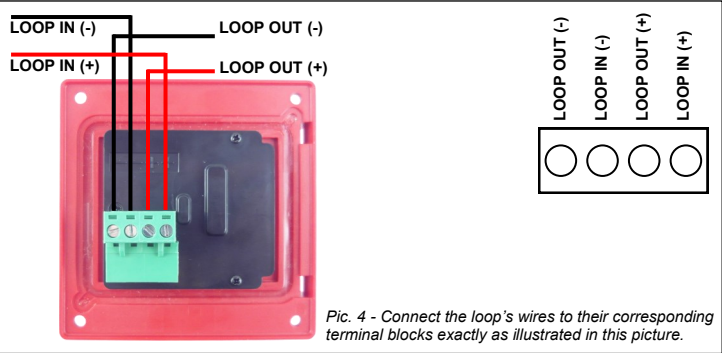

Pic. 4 - Connect the loop's wires to their corresponding terminal blocks exactly as illustrated in this picture.



Pic. 5 - Fix the loop interface plate to the back box using the screw holes highlighted.

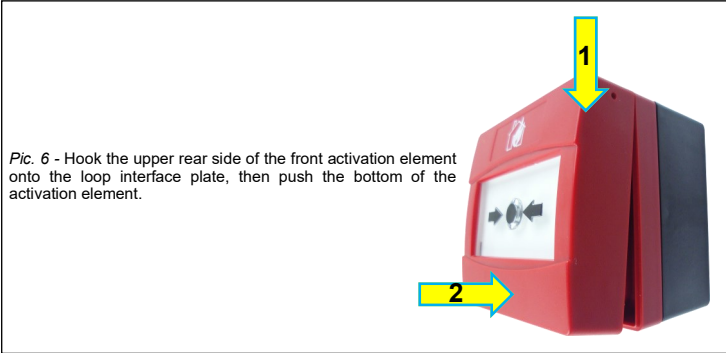

Pic. 6 - Hook the upper rear side of the front activation element onto the loop interface plate, then push the bottom of the activation element.

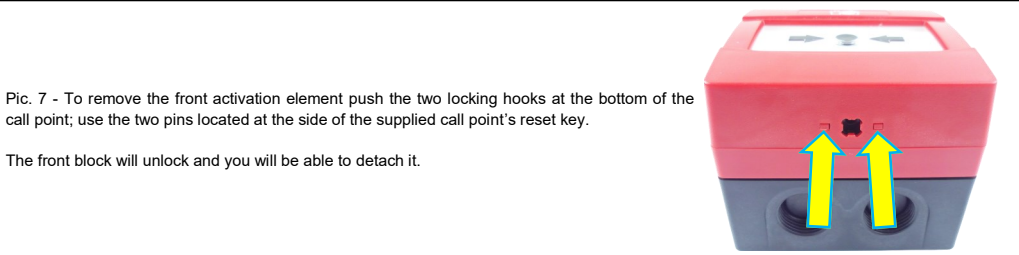

Pic. 7 - To remove the front activation element push the two locking hooks at the bottom of the call point; use the two pins located at the side of the supplied call point's reset key.

The front block will unlock and you will be able to detach it.

DEVICE ADDRESSING

This device needs to be programmed with a unique analogue loop address; address values range from 1 to 240. The address can be programmed into this device in two different ways:

- through a specific manual programmer purchasable from your fire security system supplier; the programmer is connected to the loop's interface plate, then the addressing procedure is performed (check programmer's manual to have further info).
- Using the automatic addressing feature of the control panel (if your specific model has been designed with such functionality); this can be done only after you have completed all the installation and wiring.
For more details about the "auto-addressing" feature refer to the control panel's documentation.

RECORDING LOOP NUMBER AND DEVICE ADDRESS

You can record directly on the call point its loop number and analogue address; for this purpose a special label is attached on the back of the intelligent loop interface plate (picture 8).

LOOP		DEVICE	

Pic. 8

SHORT CIRCUIT PROTECTION

HFI-CP-WP-03 is designed with a short circuit protection functionality; in the event of a short circuit occurrence, the affected loop's section is immediately isolated and the condition is signalled to the control panel. When the short is handled, the loop section is restored again and brought back to normal.

Pic. 9 - HFI-CP-WP-03 is activated by pressing the button located in the centre of the device's front window; the central red light indicator switches on and an indicator bar rises into view from the bottom of the window itself.



Pic. 10 - To restore the call point insert the supplied key into the bottom keyhole; turn the key clockwise until you hear a snap; the indicator bar will fall out of sight.

Turn the key slightly counter-clockwise and pull it outside.

TEST THE DEVICE

1. Activate the call point.
2. Check that the system is alarmed.
3. Check that the call point's red light is on.
4. Check that the bottom alarm bar is visible.
5. Restore the call point with its key.
6. Reset the control panel's alarm.

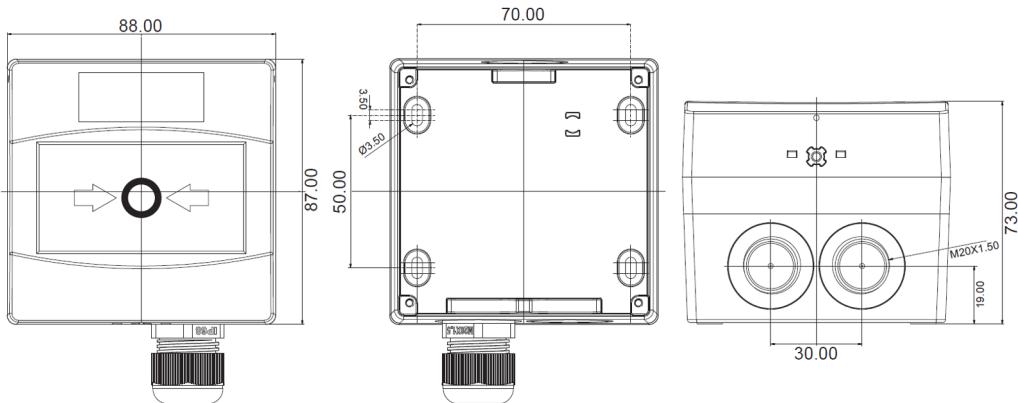

TECHNICAL SPECIFICATIONS **

Power supply voltage range	18 to 40 V _{DC} *
Standby current load	35 μ A (at 24 V _{DC})
Compatible wire's diameter range	0.5 - 2.5 mm ²
Operating temperature range (design range)	-30°C to 70°C
Operating temperature range (EN 54-11 approved range)	-10°C to 55 °C
Max humidity	95%
IP rating	67
Materials	ABS / Polycarbonate / PA6 + glass fibre
Colour	Red

* Product can operate down to 15 V_{DC}, but call points' light indicator will be disabled even when activated.

For the EN 54-11 application the supply voltage range is 18-40Vdc; at this range the visual LED indicator will be switched ON.

For the EN 54-17 application the supply voltage range is 15-40Vdc.

** Refer to TDS-ACPWR for further technical info.

WARNINGS AND LIMITATIONS

Our devices use high quality electronic components and plastic materials that are highly resistant to environmental deterioration. However, after 10 years of continuous operation, it is advisable to replace the devices in order to minimize the risk of reduced performance caused by external factors. Ensure that this device is only used with compatible control panels.

Detection systems must be checked, serviced and maintained on a regular basis to confirm correct operation. Smoke sensors may respond differently to various kinds of smoke particles, thus application advice should be sought for special risks. Sensors cannot respond correctly if barriers exist between them and the fire location and may be affected by special environmental conditions. Refer to and follow national codes of practice and other internationally recognized fire engineering standards.

Appropriate risk assessment should be carried out initially to determine correct design criteria and updated periodically.

WARRANTY

All devices are supplied with the benefit of a limited 5 years warranty relating to faulty materials or manufacturing defects, effective from the production date indicated on each product. This warranty is invalidated by mechanical or electrical damage caused in the field by incorrect handling or usage. Product must be returned via your authorized supplier for repair or replacement together with full information on any problem identified. Full details on our warranty and product's returns policy can be obtained upon request.



2831	0832
20	21
HF-20-028CPR	HF-20-028UK

Hyfire Wireless Fire Solutions Limited -
Unit B12a, Holly Farm Business Park,
Honiley, Warwickshire, CV8 1NP -
United Kingdom

EN 54-11:2001 + A1:2005

EN 54-17:2005

HF-I-CP-WP-03

For use in compatible fire detection and alarm system