

# HFW-W2W-01

## WIRE TO WIRELESS TRANSLATOR MODULE INSTALLATION INSTRUCTIONS



928n/01

### WARNINGS AND LIMITATIONS

Our devices use high quality electronic components and plastic materials that are highly resistant to environmental deterioration. However, after 10 years of continuous operation, it is advisable to replace the devices in order to minimize the risk of reduced performance caused by external factors. Ensure that this device is only used with compatible control panels. Detection systems must be checked, serviced and maintained on a regular basis to confirm correct operation. Smoke sensors may respond differently to various kinds of smoke particles, thus application advice should be sought for special risks. Sensors cannot respond correctly if barriers exist between them and the fire location and may be affected by special environmental conditions. Refer to and follow national codes of practice and other internationally recognized fire engineering standards. Appropriate risk assessment should be carried out initially to determine correct design criteria and updated periodically.

### WARRANTY

All devices are supplied with the benefit of a limited 3 years warranty relating to faulty materials or manufacturing defects, effective from the production date indicated on each product. This warranty is invalidated by mechanical or electrical damage caused in the field by incorrect handling or usage. Product must be returned via your authorized supplier for repair or replacement together with full information on any problem identified. Full details on our warranty and product's returns policy can be obtained upon request.



2831/0051/0681

0832

10

21

HF-20-015CPR

HF-20-015UK

Hyfire Wireless Fire Solutions Limited - Unit B12a, Holly Farm Business Park, Honiley, Warwickshire, CV8 1NP - United Kingdom

EN 54-25:2008

EN 54-17:2005

EN 54-18:2005

HFW-W2W-01

For use in compatible fire detection and alarm system

## GENERAL DESCRIPTION

The wire to wireless translator module is a device which interfaces the hard wired, Vega intelligent-analogue loop to the Sagittarius wireless system \*.

It actually simply expands the analogue system, permitting the addition of fire detecting devices based on the Sagittarius wireless communication protocol for monitoring and control.

The translator, as any other Vega device, is powered directly by the analogue loop, and is to be used with control panels that implement the Vega communication protocol for monitoring and control; as a matter of fact its main function is to act literally as a translator between the Vega and the Sagittarius protocols.

\* Vega indicates a family of addressable, hard-wired connectable, analogue-intelligent devices used in the fire detecting field which can dialogue with a control panel by the means of an adequate communication protocol.  
These devices use the Vega protocol.

Sagittarius indicates a family of addressable, wireless connectable, analogue-intelligent devices used in the fire detecting field which can dialogue by radio with an adequate protocol translator which permits the managing of those devices by an hard-wired connected control panel as if they where part of the detecting line.  
These devices use the Sagittarius protocol.

**Note: The latest release of the wireless system configuration software is available from the manufacturer's website.**

## DEVICE'S OVERVIEW

Following is an overview of the translator: picture 1 for a front view of the device; picture 2 for an inside view; picture 3 for its dimensions; table 1 for its technical specifications.



Picture 1 - device overview

### TECHNICAL SPECIFICATIONS \*\*\*\*

Loop power supply range		from 18V <sub>dc</sub> to 40V <sub>dc</sub>
Typical current consumption		20mA (at 24V <sub>dc</sub> )
Operating frequency range		868.15 MHz - 869.85 MHz
Radiated power range		5 dBm (3 mW)
Radio signal's modulation type		FSK
Number of frequency channels		7
Communication range with a wireless expander device		600 m (in open space) *
Communication range with other wireless devices		200 m (in open space) *
Maximum linked wireless devices		32 **
Maximum linked wireless expander devices		7 ***
Temperature range		from -30°C to +50°C
Tolerated humidity range (no condensing)		from 5% RH to 90% RH
Dimensions (without antennas)		120 mm x 160 mm x 51 mm
Number of antennas		2
External antenna's length		74 mm
Weight		300 g

Table 1

\* Ideal operating range: may vary consistently according to environmental conditions.

\*\* 16 output devices (output modules, sounders...) maximum.

\*\*\* 5 expanders in cascade connection, maximum.

3 expanders connected to another one, maximum.  
\*\*\*\* Check latest version of document TDS-VW2WX for further data, obtainable from your supplier.



Power source type ES1, PS2

Picture 3 - device dimensions

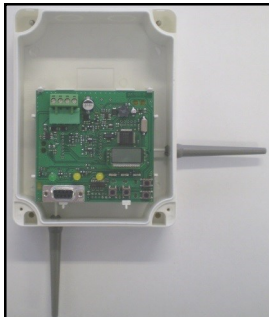
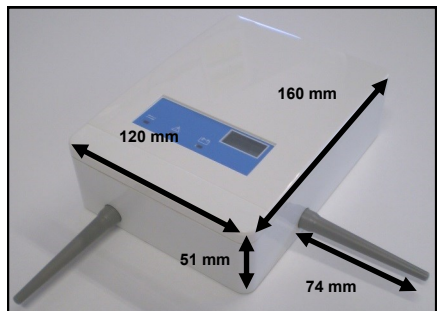

Picture 2 - device's inside view

## **PART 1 - SURFACE INSTALLATION**

### **DEVICE POSITIONING FOR RADIO COMMUNICATION PERFORMANCE AND STABILITY**

The translator must have a good radio communication with its wireless system's devices. In order to achieve this, before positioning it and installing it, apply scrupulously the following points:

- select, for the translator, a radio channel that is free or relatively free of other signals; avoid, if possible, used channels. In order to obtain this, use the supplied RF-Analyze program.  
Identify the translator's wireless system with a unique system number.

For more data about radio channels and system identification refer to the programming section.

- Avoid installing the translator close to:
  - equipment using large amounts of electrical current
  - large metal objects, structures or metal ceiling structures
  - fluorescent lighting fixings
  - computers, their cabling and network cabling.
- If there are other translators or wireless system expander modules, keep a distance between them of at least 2 meters. In general every installed radio device (child devices included) must have a minimum distance of at least 2 meters from each other.
- It is recommended to install the translator and eventual expanders at an height from the floor of at least 2 - 2.5 meters.
- Install the translator perfectly flat on the wall.
- The translator must be installed perfectly straight on the wall; this means that the antenna under the device must be perpendicular to the floor and the antenna on the right of the device must be parallel to the floor.
- Environmental parameters (temperature, humidity and so on) must be in the ranges specified in the translator's technical specifications, which can be found at the beginning of this manual; this point applies, obviously, to all wireless devices.
- After having installed the translator, make sure that the translator's child devices (sensors, call points, etc.) are reached by a good, strong signal (refer to the single device's manuals) in their position of installation.  
Radio transmission ranges for the translator can found in the technical specifications at the beginning of this manual.

**- IF, IN THE SYSTEM, IS PRESENT AT LEAST AN EXPANDER MODULE USE ONLY THE WIRELESS SOFTWARE FOR CONFIGURING AND ADMINISTERING THE SYSTEM! AVOID USING THE PUSH BOTTONS / DISPLAY INBUILT SYSTEM!**

### **INSTALLING THE ANTANNAS TO THE TRANSLATOR**

In the case that the antennas are delivered separate from the main device, these need to be connected to it.  
The translator device is composed by 2 PCBs: the outer one is the Vega protocol interface PCB and the inner one is the radio frequency, Sagittarius-protocol one. Antennas must be securely connected to the Sagittarius PCB, and, specifically, to the connecting terminal blocks (picture 4).

- First of all uninstall the Vega PCB from the device by lifting the blocking plastic hooks and by pulling out the circuit board; during this operation do not disconnect the flat cable connecting the two PCBs.
- One by one, for every antenna, insert the conductive end of them into the device's lateral holes and, then, into the relative Sagittarius PCB's terminal blocks, exactly as visualized in picture 4.
- Securely screw the antenna endings to the terminal blocks into which they have been fitted in, and assure that the antennas are secure and perpendicular to their corresponding device's lateral surface plane.
- Reinstall securely and correctly the front Vega PCB into the device, checking that the flat cable has not been accidentally disconnected.

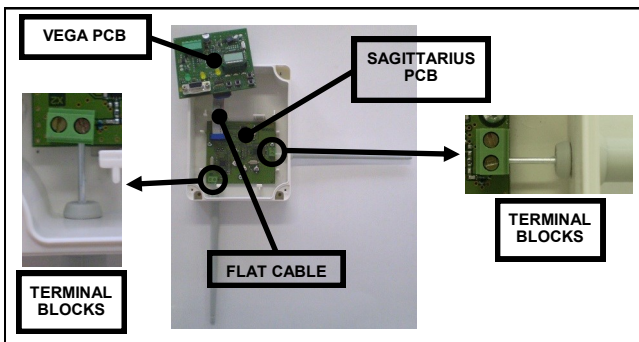

Picture 4 - antennas installation

## **SURFACE INSTALLATION PROCEDURE**

The translator's circuitry is already equipped with its own surface mounting box, designed with four 20 mm breakable entry holes (two at the top and two on the upper side of the rear of the box), allowing sealed, cable gland fitted, loop cables to be connected to the device (see picture 5).

- Find a suitable location for the translator.
- Drill the required number of holes on the wall (see picture 6 for an indication of the screw inserting locations on the box and figure 7 for an indication of their distances between each other and their diameter).
- Prepare the cable openings on the box.
- Securely and adequately fix the device's box to the wall with adequate screws (DO NOT use the countersunk type).

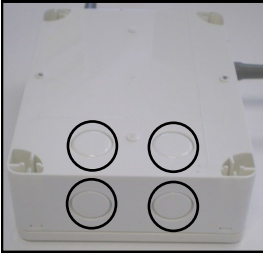

*Picture 5 -  
breakable  
wire entry  
holes*

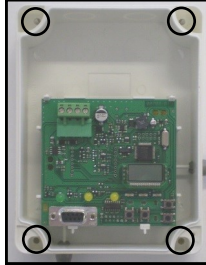

*Picture 6 -  
wall fixing  
screw holes*

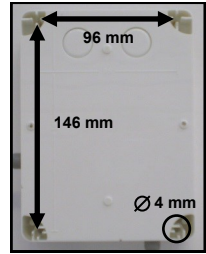

*Picture 7 -  
distances  
between  
wall fixing  
screw holes  
and their  
diameter*

## PART 2 - WIRING

### TRANSLATOR'S WIRING

For wiring bear in mind those two points:

- refer to and follow national codes of wiring and cabling practice and other internationally recognized standards
- loop terminals are polarity sensitive, so connect them adequately according to the following instructions.

Fit an adequate cable gland to the loop's cables and apply it to the entry hole; successively feed the wires into the box, giving them a sufficient length to be connected to the device's terminals. If other knockout holes have been opened, seal them with blanking glands in order to maintain the device's original IP rating.

Connect the analogue loop's cable to the device's terminal blocks as per wiring scheme in picture 8 and per table 2.

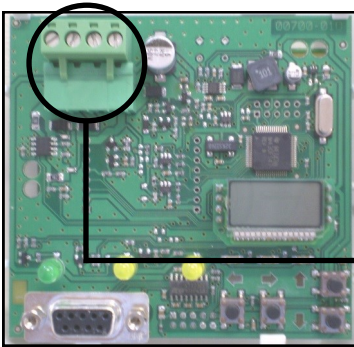
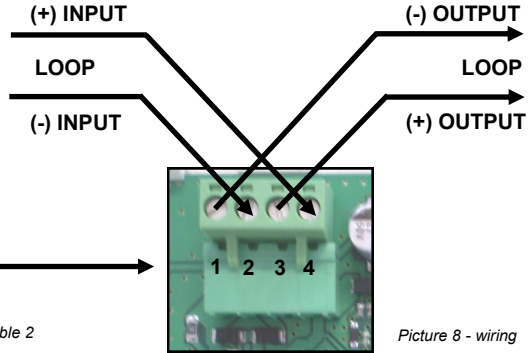

Table 2



Picture 8 - wiring

Terminal	Function	Description	Comment
1	Line - out	Line negative out	Short circuit protected
2	Line - in	Line negative in	Short circuit protected
3	Line + out	Line positive out	
4	Line + in	Line positive in	

**WARNING**  
Disconnect loop power before installing the translator



**CAUTION**  
Electrostatic sensitive device. Observe precautions when handling and making connections

### SHORT CIRCUIT ISOLATORS

All standard Vega analogue devices (but not the Vega Lite series devices) are equipped with integrated short circuit isolators which monitor the analogue loop and can be activated by the control panel.

SHORT CIRCUIT ISOLATORS SPECIFICATIONS		
Maximum rated continuous current with the switch closed	$I_c$ max	1 A
Maximum rated switching current (under short circuit conditions)	$I_s$ max	1 A
Maximum leakage current with the switch open (in isolated state)	$I_l$ max	14 mA (at 40 V)
Maximum series impedance with the switch closed	$Z_c$ max	0.50 $\Omega$

Table 3

### **PART 3 - INSTALLATION COMPLETION**

#### **TRANSLATOR'S INSTALLATION COMPLETION**

Configure the radio system either directly on the translator via its keyboard / display system or through a personal computer connected to it via RS232. System's configuration programming will be described later in this manual.

Mount the device's cover over its box, inserting the upper side first (see picture 9). Securely screw the cover on the box by inserting the supplied screws into the front cover's holes (see picture 10).

Insert the plastic mask onto the front plastic cover (see picture 10).

After having installed the system remember to check the translator's effectiveness; translator's testing will be described later in this manual.

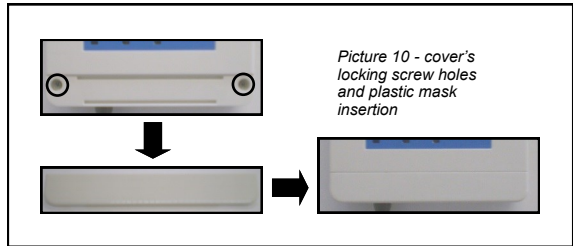
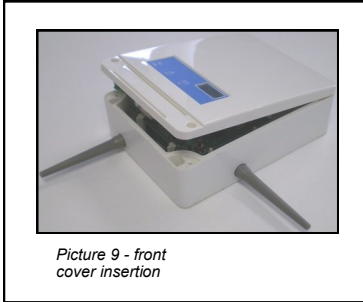

## PART 4 - PROGRAMMING AND CONFIGURATION

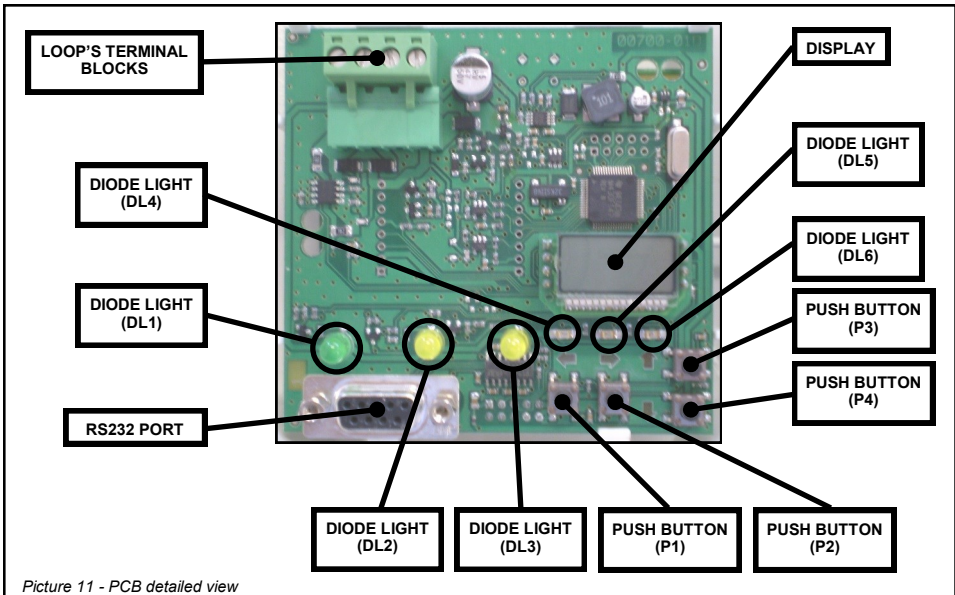

Picture 11 - PCB detailed view

### TRANSLATOR'S COMMANDS, DISPLAYS AND CONNECTIONS GENERAL DESCRIPTION

**LOOP TERMINAL BLOCKS:** used to connect the translator to the analogue loop.

**DISPLAY:** indicates translator's status messages, alarm messages and it is used to configure the wireless system.

**RS232 PORT:** by connecting this port to a personal computer via serial wire, it is possible to configure the wireless system using the Wirelex software

**DIODE LIGHT (DL1):** green colour (blinking): indicates that the translator is being polled by the analogue control panel.

**DIODE LIGHT (DL2):** yellow colour: indicates that the translator or a system's device is in a radio fault condition; **it also indicates that a wireless device has lost communication with the translator.**

**DIODE LIGHT (DL3):** yellow colour: indicates that a wireless device connected to the translator has a battery low.

**DIODE LIGHT (DL4):** red colour: indicates that the translator is searching for a wireless device; in particular, it switches on during the linking and addition phase of a radio device to the wireless configuration.

**DIODE LIGHT (DL5):** red colour: indicates that a device type, shown on the display, corresponding to a certain address, is configured on the wireless system (activates only when the LIST command is in use).

**DIODE LIGHT (DL6):** not used.

**PUSH BUTTON (P1):** used to exit out from a menu or sub-menu; exit from a sub-menu if the operator does not accept the changes made.

**PUSH BUTTON (P2):** used to enter into a menu or sub-menu; confirm the changes made to parameters.

**PUSH BUTTON (P3):** used to navigate through menus or sub-menus; change parameters (value increase).

**PUSH BUTTON (P4):** used to navigate through menus or sub-menus; change parameters (value decrease).

## TRANSLATOR'S WIRELESS SYSTEM CONFIGURATION PROGRAMMING

The wireless system configuration can be programmed in these ways:

- by using the Wirelex software installed on a personal computer connected to the translator via RS232 serial port.  
**THIS APPROACH IS MANDATORY IF THERE IS AT LEAST ONE EXPANDER MODULE IN THE SYSTEM!**

- By using the keys and display on the device.

**THIS APPROACH MUST BE ABSOLUTELY AVOIDED IF, IN THE SYSTEM, IS PRESENT AN EXPANDER MODULE!**

For the Wirelex configuration simply connect the personal computer's serial port to the RS232 port on the translator; install the Wirelex software on the PC and follow the instructions on the Wirelex manual.

The present manual describes only the system's configuration through the usage of the translator's display and command keys.

For the definition of the meanings of the display messages refer to Appendix A.

For a reference to the general menu, sub-menu and command structure of the translator refer to Appendix C.

**Accessing a menu or sub-menu disables the main control panel's Vega protocol communication; it can be restored by returning on the BLANK display or by not touching the keypad for 90 seconds.**

### NOTE ON THE WIRELESS SAGITTARIUS EXPANDER

The wireless Sagittarius expander (device designed to expand the wireless system area) can be configured and administered ONLY through the use of the Wirelex program. Refer to Wirelex and expander's documentation for having more information.



## TRANSLATOR DEVICE ADDRESSING

Translator must be given an address on the Vega loop; the control panel will program, on its configuration, the addresses of the wireless system's devices starting from the one of the translator; for example the translator has an address of 001; two wireless devices are linked to it: as a consequence the control panel will configure its system configuration with address 001 (translator) and the other two wireless devices with 002 and 003 addresses respectively. There is no need to preserve all 32 addresses for the translator (32 is the maximum number of radio devices addressable by one translator) if many of them will remain unused, but it is necessary to preserve the addresses that will actually be used.

Translator's address can be assigned in two ways:

- directly by the installer through the SA command

- through the automatic addressing of the Vega loop, operation that can be performed by the control panel, if designed with such feature. If a translator's starting address was previously specified, it will be overwritten by a new one (**so as the ones of the successive wireless devices**), assigned by the automatic addressing process.

In order to address manually the translator follow this procedure, starting from the initial blank display; bear in mind that if the address is not specified, the device will preserve its previous address value.

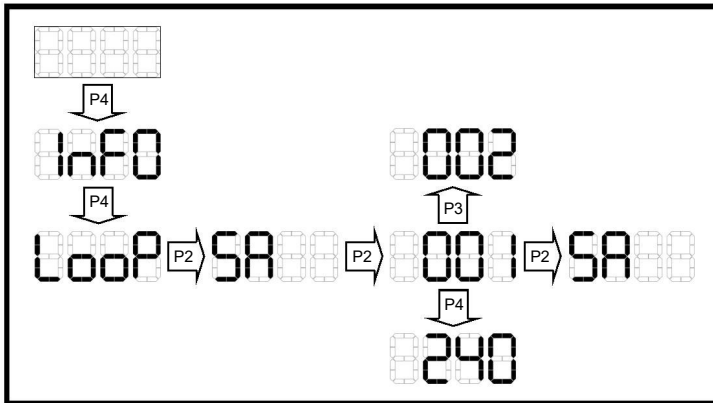

## TRANSLATOR'S CHANNEL SELECTION

The translator must operate on one of the 7 prearranged channels; it must be specified if you want a radio channel for data interchange different from the default 001. Channel range span from 001 to 007. The procedure to be used is the following:

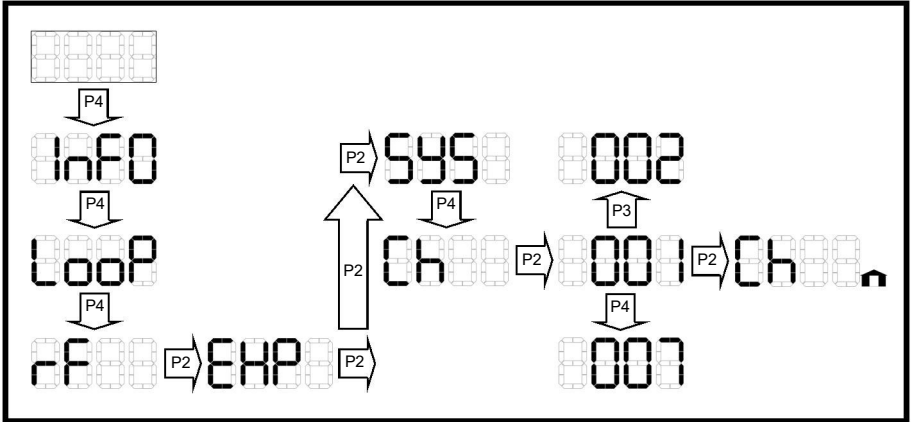

As can be seen, after channel selection, a little house icon appears on the lower right side of the display; this indicates the user that the translator's parameters have been changed.

Those changes can be discarded by the pressure of the P1 button.

If the operator wanted to keep them and make other changes he can still use the EXP sub-menu's commands (with the house icon still present).

**In order to make the radio frequency channel parameter change effective, the INIT command must be used** (the house icon must be still present); please read carefully THE INIT COMMAND paragraph, since **USING INIT WILL CAUSE THE WHOLE SYSTEM CONFIGURATION TO BE ERASED!**

## TRANSLATOR'S SYSTEM SELECTION

More than one translator can operate on a single channel; to do so it is **warmly advisable** to identify univocally the system configured by every single translator in order to avoid data interchange conflicts between radio devices.

For instance: on channel 3 are operating 3 translators: alpha, beta and gamma, and everyone of them make up a wireless system; it is warmly advisable that every translator has its own system code: 1 for alpha, 2 for beta and 3 for gamma.

Translator design provides for 256 prearranged identifiers that range from 000 to 255; there is no default identifier, nevertheless selecting one for the system prevents potential trouble.

It is advisable not to put too many translator-wireless systems on a single channel, but to spread them across the channel range: too many systems on a single channel can be deleterious towards their efficiency.

In order to assign a system identifier to the translator follow this procedure, starting from the initial blank display:

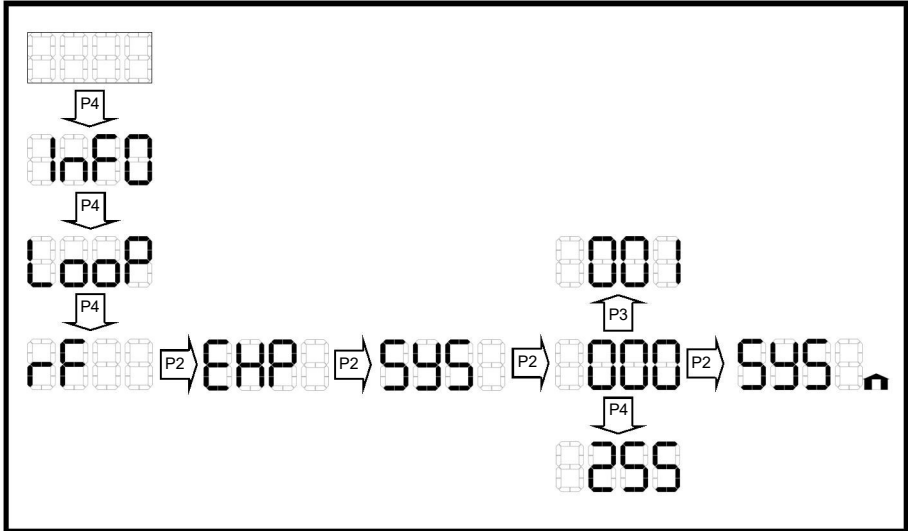

As it can be seen, after the selection of the system identifier, a little house icon appears on the lower right side of the display; this indicates the user that the translator's parameters have been changed.

Those changes can be discarded by the pressure of the P1 button.

If the operator wanted to keep them and make other changes he can still use the EXP sub-menu's commands (with the house icon still present).

**In order to make the system identifier parameter change effective, the INIT command must be used** (the house icon must be still present); please read carefully THE INIT COMMAND paragraph, since **USING INIT WILL CAUSE THE WHOLE SYSTEM CONFIGURATION TO BE ERASED!**

## THE INIT COMMAND

In order to make effective the changes made to the translator's channel and system's identifier parameters, an INIT (initialize) command must be performed.

The INIT command must not be confused with the RES (reset) command, which is used to reset the wireless system from fault or fire conditions.

In order to perform an INIT follow this procedure, starting from the EXP sub-menu's command list (with the house icon still present on the lower right side of the display).

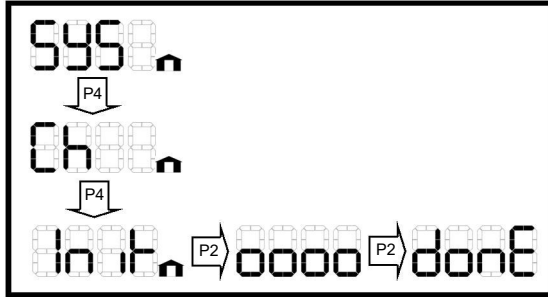

**WARNING: USING THE INIT COMMAND WILL CAUSE THE WHOLE SYSTEM CONFIGURATION TO BE ERASED!**

## RESETTING THE WIRELESS SYSTEM

The wireless system can be reset (from fault or fire conditions) directly from the translator, through the RES command; do not confuse this command with the INIT (initialize) command.

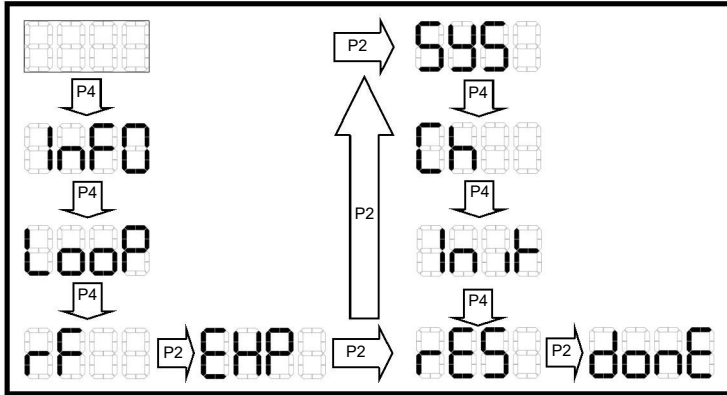

## GATHERING WIRELESS SYSTEM INFORMATION: THE INFO MENU

The INFO menu is used to gather information on the configured wireless system and to retrieve the firmware's version number of the Vega interface.

The command used for viewing the wireless system's devices is LIST; it gives the device type corresponding to a specific address selected by the user; when the device's type is visualized, DL5 switches on; its use is as follows:

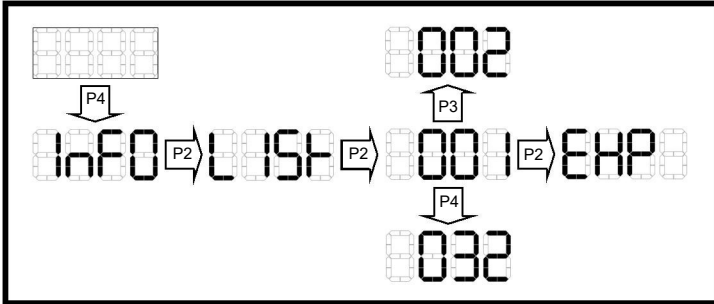

In order to retrieve the firmware's version of the device's Vega interface, the VEGA command must be used:

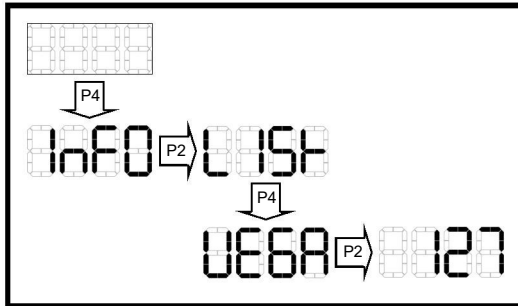

Dots cannot be visualized on the display, so, considering the above example, the 127 should be considered as 1.27.

### LOADING THE WIRELEX-CONFIGURED SYSTEM

When the Wirelex program, run on a personal computer, is used to generate the wireless system, it is programmed, through RS232, into the Sagittarius radio frequency PCB's flash memory \*.

In order to make this new configuration utilizable, it must be loaded into the Vega PCB's flash memory \*\*: the LOAD command is used to perform such operation.

If this operation is not performed, after the radio frequency PCB is programmed, a load error (LOER) occurs.

\* The radio frequency PCB is the one connected directly to the two antennas.

\*\* The Vega PCB is the one connected directly to the analogue loop.

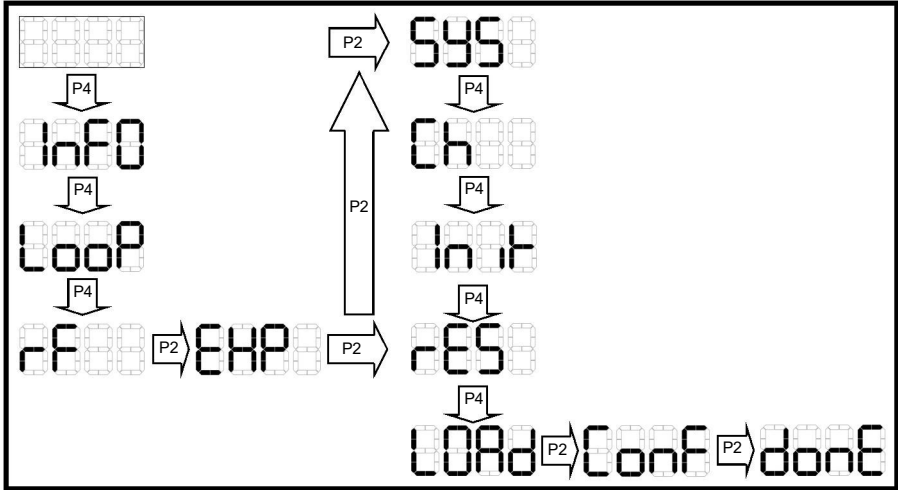

**WARNING: USING THE LOAD COMMAND WILL CAUSE THE PRE-EXISTING SYSTEM CONFIGURATION TO BE ERASED!**

## **WIRELESS SYSTEM'S DEVICES MANAGEMENT**

Wireless devices can be added or deleted from the wireless system configuration of the translator. The translator's programmer menu, in order to perform such system management, is structured as described in the following paragraphs.



## SENSOR DEVICES MANAGEMENT

Following is the procedure for reaching the fire sensor's sub-menu for adding or deleting this kind of device from the wireless system:

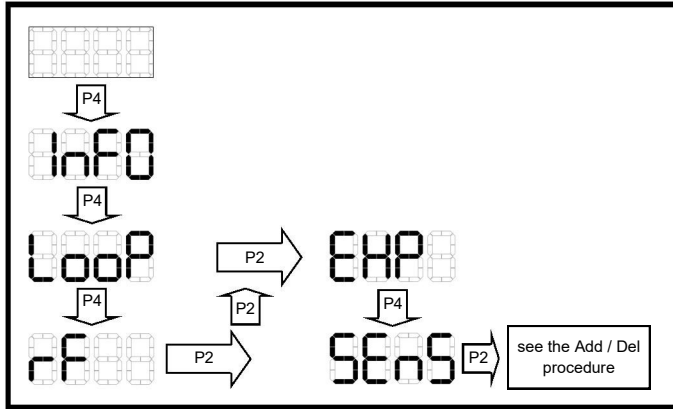

Refer to Appendix B for a reference to the installable sensing devices with this sub-menu.

**INPUT DEVICES MANAGEMENT**

Following is the procedure for reaching the input device's sub-menu for adding or deleting this kind of device from the wireless system:

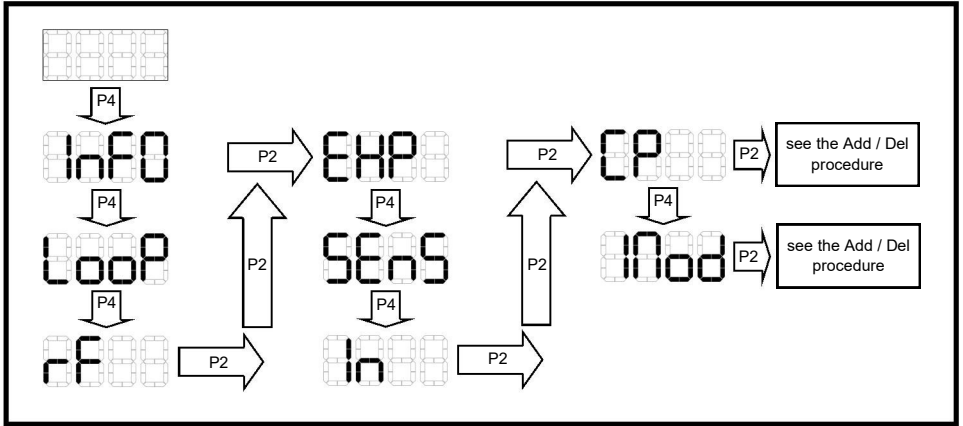

Refer to Appendix B for a reference to the installable input devices with this sub-menu.

## OUTPUT DEVICES MANAGEMENT

Following is the procedure for reaching the output device's sub-menu for adding or deleting this kind of device from the wireless system:

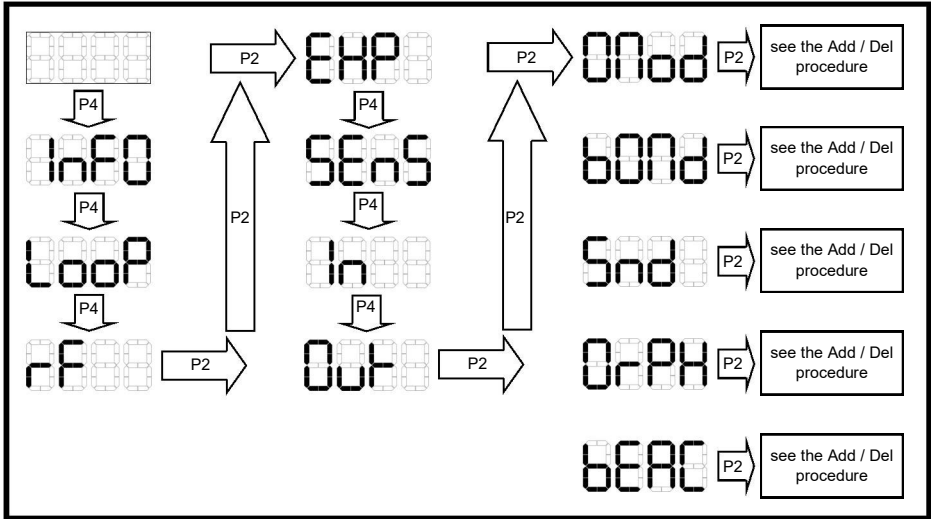

Refer to Appendix B for a reference to the installable output devices with this sub-menu.

## THE ADD / DEL PROCEDURE

Following is the common specific procedure for adding or deleting the devices from the wireless system; it has been referenced in the previous visual procedures with the "see the Add / Del procedure" text box.

The ADD command procedure is performed in this way:

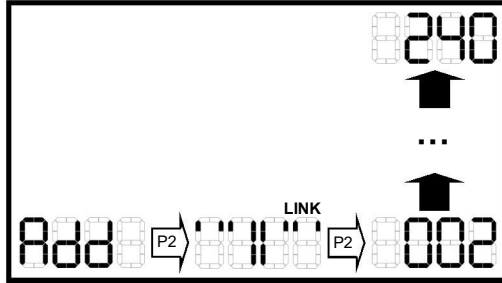

After the ADD command is performed, the translator waits the installer to trigger the linking of the child device by acting on the child device's "link-program switch" (see the specific installation manuals of these devices); during this phase, the LINK message is displayed and DL4 is switched on the translator; as a matter of fact the translator is waiting to achieve, in its configuration, the child device.

After the linking for device's addition has been performed, the translator assigns automatically a progressive address to it, starting the whole sequence from the successive one assigned to the translator by the installer through the SA ("starting address") command. The automatically assigned address is signalled on the translator's display; this indicates that the child device is linked and has been achieved by the wireless system configured in the translator.

Following is the DEL ("delete") command procedure, applied to devices that are already present on the wireless configuration:

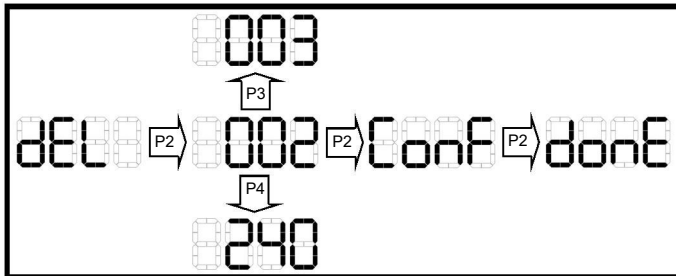

Bear in mind that this command deletes a device from the configuration of the translator, but not from the configuration of the main control panel:

**FOR THIS REASON THE USE OF THE CLRE COMMAND ("CLEAR EMPTY SPACES") IS WARMLY SUGGESTED AND THE RE-ACHIEVEMENT OF THE SYSTEM BY THE MAIN CONTROL PANEL IS MANDATORY.**

Following is the translator's response to the DEL command if NO devices are present in the wireless configuration:

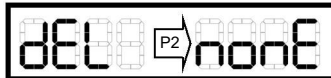

## CONFIGURATION'S DEFRAGMENTATION: THE CLRE COMMAND

If one or more devices are removed from the wireless configuration (see the DEL command), empty address "spaces" remain on it; for example lets take a system addressed with addresses 001, 002, 003, 004 and 005; device addressed in 003 is deleted from the configuration, so 001, 002, 004 and 005 remain: virtually speaking, address 003 is missing on the sequence, there is "an empty space", the sequence is fragmented. By performing the CLRE (that means "clear empty spaces") command the empty space is refilled, the sequence is defragmented and reintegrated, so the new address's configuration sequence will be 001, 002, 003, and 004; devices addressed successively the 003 remain, obviously, still configured, but are re-addressed with a position less.

**Bear in mind that this defragmentation is made only on the translator's configuration, and not on the one of the main control panel.**

It is warmly advisable to use always the CLRE command after deleting devices, but, if this kind of changes have been done,

**THIS COMMAND IS MANDATORY BEFORE PERFORMING THE AUTOMATIC ADDRESSING FROM THE CONTROL PANEL!**

The following procedure must be used:

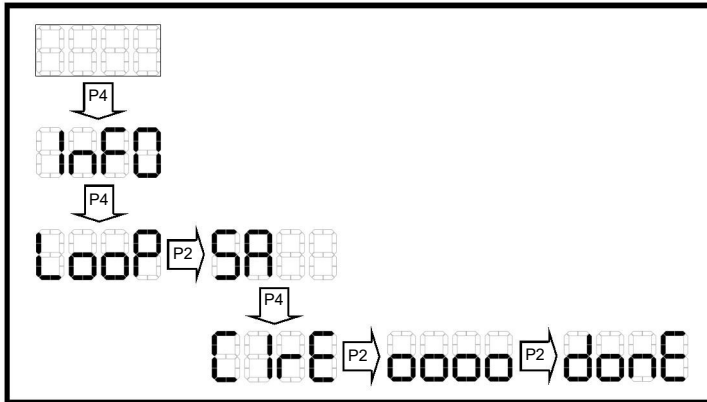

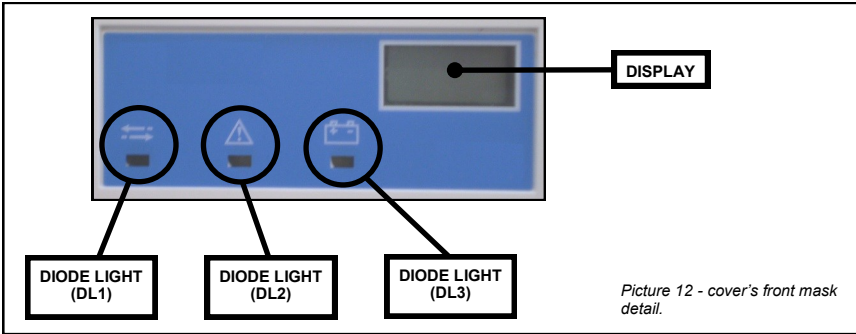

**TRANSLATOR COVER'S FRONT MASK**

After the translator's cover has been closed over its box, it's possible, still, to see DL1, DL2, DL3 and the display through the front mask of the cover (see picture 12).

**GENERAL FAULTS**

The translator signals general fault conditions of itself and its child devices. To be more specific, general faults can be:

- a child device is not communicating anymore with the translator
- channel jamming is being deliberately performed in order to compromise wireless data interchange
- load error: the Sagittarius radio frequency PCB has been programmed, using Wirelex, with a new system configuration, but not the Vega PCB through the LOAD command
- the Vega and Sagittarius PCBs are disconnected (the connecting ribbon cable must be securely connected).

In case of these faults, DL2 is switched on and a fault message is sent to the control panel.

**BATTERY FAULTS**

The translator signals child device's battery fault conditions: if their main or secondary battery are low in charge, this event is signaled by the translator on the display, with the address and the indication whether the shortage occurs in the primary or secondary battery (see picture 13 and 14).

In case of this kind of fault DL3 is switched on and a fault message is sent to the control panel.

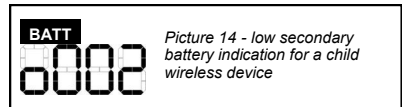
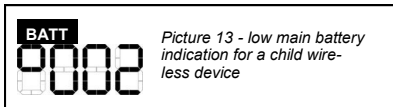

**TAMPER FAULTS**

The translator signals child device's tamper events. If a tampering attempt is performed, this event is signaled by the translator on the display with the address of the child device and a little spanner icon on the right side (see picture 15).

In case of this kind of fault, a fault message is sent to the control panel.

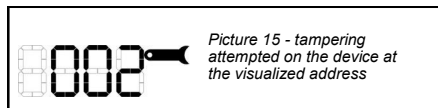

## EXPANDER'S FAULTS

Expander's faults, connected to the translator, are signalled on the display; in these cases DL2 switches on. The EXP indication is visualized on the display, followed by a numeric digit that indicates not an address, but the numeric sequential identification of the expander in the system; it can range from 1 to 7.

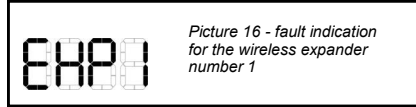

## FATAL FAULTS

A fatal fault is an irreversible error, caused by hardware problems. In this case the only solution to this fault condition is the substitution of the device itself.

This fault is not signalled on the diodes / display system of the translator, but a fault message is sent to the control panel.

## FIRE EVENTS

The translator can signal fire events. If a child device indicates a fire event, this is signaled by the translator on the display with a message like in picture 17.

In this case a fire message is sent to the control panel.

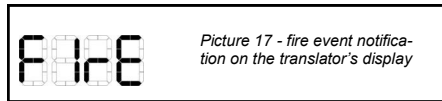

## DEVICE'S FAULT AND FIRE EVENTS REFERENCE TABLES

For a reference concerning how fault and fire events, related to every single wireless device type, are indicated by the translator, consult Appendix D.

## FAULT AND FIRE EVENTS RESET

To reset the translator from fault or fire events it is necessary to:

1) solve the cause of the fire or fault events

2) one of these two actions can be performed:

- send the reset command from the main control panel: the translator, the wireless child devices and the whole system will reset successively
- reset the wireless system from the translator; the main control panel will, successively, exit the alarmed / fault condition if its triggering cause was exclusively detected in the wireless system.

## TESTING

In order to test the functionality of the installed translator, it must be tested that the device relays data packages to the main control panel; by adequately acting on a wireless call-point or a sensor (**linked to the translator under test**), generate an alarm detection message that will be sent through the translator up to the control panel; the control panel will trigger, consequently, an alarm condition.

After each test the control panel or the translator must be reset by its specific command.

**All devices must be tested after installation and, successively, on a periodic basis.**

## MAINTENANCE

- 1) Before starting any maintenance work, isolate and disable the system, in order to avoid accidental and unwanted fault detection conditions.
- 2) Remove the front cover from the translator's wall box.
- 3) Perform the planned necessary maintenance operations.
- 4) After the device has been serviced, reinstall correctly the translator's cover on its main body, re-apply power to the system and check correct operation as described under the TESTING paragraph.

## APPENDIX A - DISPLAY MESSAGES DEFINITIONS

The following list defines the messages used by the translator's display.

### MAIN MENUS

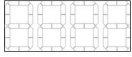

**BLANK:** this is the starting display; no command, menu or sub-menu is selected. If other displays are visualized, it is possible to obtain again this screen by pressing P1 an adequate number of times or by waiting 90 seconds without touching the keypad.



**INFO:** information gathering main menu. By proceeding from here it is possible to have information on the wireless system configuration and the Vega interface firmware's version.

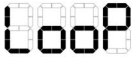

**LOOP:** Vega loop interface's parameters setting main menu. By proceeding in this menu it is possible to set manually the translator's address and defragmentate the translator wireless system address configuration.



**RF:** radio-frequency's main menu. By proceeding from this menu it is possible to manage the wireless system configuration.

### SUB-MUNUS



**EXP:** "expander" sub-menu; in this case "expander" refers solely to the translator's radio interface and not to an expander device. Contains the commands to select the system's identifier, select the operating channel, load a configuration generated with the Wirelex program or reset the system from fault or fire conditions.



**SENS:** sensor sub-menu: contains the commands to add or delete wireless fire sensors to the system.

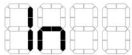

**IN:** this sub-menu contains the sub-menus of the wireless input devices.

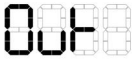

**OUT:** this sub-menu contains the sub-menus of the wireless output devices.



**CP:** this sub-menu contains the commands for adding or deleting wireless call points.



**IMOD:** this sub-menu contains the commands for adding or deleting wireless input modules.



**OMOD:** this sub-menu contains the commands for adding or deleting wireless output modules.



**BOMD:** battery output module; with the commands of this sub-menu, this type of wireless, battery supplied output module can be added or deleted from the wireless system configuration. Those commands apply to the wireless remote indicator lamp too.

**SND:** sounder. This sub-menu contains the commands for adding or deleting wireless sounders.

**ORPH:** "Orphey" voice annunciator . This sub-menu contains the commands for adding or deleting wireless annunciators.

**BEAC:** beacon. This sub-menu contains the commands for adding or deleting wireless beacons.

## COMMANDS

**LIST:** this command lists the configured wireless devices on the system; the user, selecting an address, will see the device associated to it; DL5 will switch on when a device type is visualized.

**VEGA:** visualizes the firmware version of the translator's Vega analogue interface.

**SA:** start address. This command permits the user to assign the Vega analogue address to the translator; it is also the starting address from which the configured child devices will be addressed.

**CLRE:** "clear empty spaces". If devices are deleted from the configuration, unused addresses, or "empty address spaces", remain in the wireless configuration; this command refills those "spaces".

**SYS:** system. This command permits the setting of the system identification number.

**CH:** channel. This command permits the setting of the translator's operating channel.

**INIT:** initialize. This command makes effective the changes made with the SYS and CH commands. **After having performed this operation, the actual translator's wireless system configuration will be erased.** Do not confuse this command with the RES command.

**RES:** reset. This command resets the translator from fault or fire conditions. Do not confuse this command with the INIT command.

**LOAD:** the Sagittarius radio frequency PCB has been programmed, using Wirelex, with a new system configuration; now the Vega PCB is to be aligned to the new configuration through this command, in order to make it utilizable.



**ADD:** permits to add a wireless device to the translator's configuration.



**DEL:** permits to delete a wireless device from the translator's configuration.



**CONF:** confirm. The execution of this command is requested as a confirmation of a previously performed operation.

MESSAGES

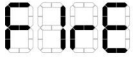

**FIRE:** indicates a fire alarm sent by one of the configured devices.



**TAMPER:** one of the configured devices, having the address shown, has been tampered.

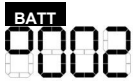

low battery indication; the primary battery of the device at the displayed address is low.

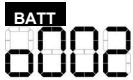

low battery indication; the secondary battery of the device at the displayed address is low.

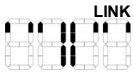

**LINK:** the translator is waiting to be linked and achieve, in its configuration, a wireless device. During the visualization of this display, DL4 is switched on.



**P + ADDRESS:** a wireless photo detector has been achieved in the translator's configuration with the displayed address.



**M + ADDRESS:** a wireless multi-criteria detector has been achieved in the translator's configuration with the displayed address.



**H + ADDRESS:** a wireless thermal detector has been achieved in the translator's configuration with the displayed address.

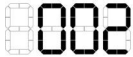

**BLANK + ADDRESS:** **only after the link message:** a wireless device has been achieved in the translator's configuration with the displayed address.

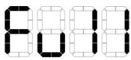
The word "FULL" is displayed in a large, hollow, monospace font where each letter is composed of a grid of small squares.

**FULL:** all configuration addresses of the translator have been used.

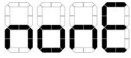
The word "NONE" is displayed in a large, hollow, monospace font where each letter is composed of a grid of small squares.

**NONE:** no items exist in the configured devices set.

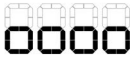
The word "WAIT" is displayed in a large, hollow, monospace font where each letter is composed of a grid of small squares.

**WAIT:** the translator is performing an operation and communicates the user, with this display, to wait.

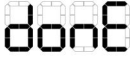
The word "DONE" is displayed in a large, hollow, monospace font where each letter is composed of a grid of small squares.

**DONE:** a certain operation has been performed by the translator.

The word "LOER" is displayed in a large, hollow, monospace font where each letter is composed of a grid of small squares.

**LOER:** load error. The Sagittarius radio frequency PCB has been programmed, using Wirelex, with a new system configuration, but not the Vega PCB through the LOAD command.

The word "EXP" followed by a plus sign and a number (e.g., "EXP1") is displayed in a large, hollow, monospace font where each character is composed of a grid of small squares.

**EXP + NUMBER:** indicates a fault on an expander present in the translator's wireless system; the subsequent number is not an address, but a sequential number univocally identifying the expander.

#### **CONFIGURED DEVICE TYPES**

The following messages are visualized with the performance of the LIST command, when the user wants to see the device type associated to a certain address; during their visualization DL5 switches on, in order not to confuse them with their homonymous sub-menus.

The word "PHT" is displayed in a large, hollow, monospace font where each letter is composed of a grid of small squares.

**PHT:** wireless photo detector.

The word "MULT" is displayed in a large, hollow, monospace font where each letter is composed of a grid of small squares.

**MULT:** multi-criteria, optical-thermal wireless detector.

The word "THR" is displayed in a large, hollow, monospace font where each letter is composed of a grid of small squares.

**THR:** thermal wireless detector.

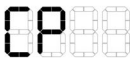
The word "CP" is displayed in a large, hollow, monospace font where each letter is composed of a grid of small squares.

**CP:** wireless call point.

The word "SND" is displayed in a large, hollow, monospace font where each letter is composed of a grid of small squares.

**SND:** wireless sounder.

The word "IMOD" is displayed in a large, hollow, monospace font where each letter is composed of a grid of small squares.

**IMOD:** wireless input module.

The logo for OMOD is rendered in a digital, dot-matrix style. Each letter is composed of a grid of small squares, with some squares missing to form the shape of the letters. The 'O' and 'M' are tall, while the 'O' and 'D' are shorter.

**OMOD:** wireless output module.

The logo for BOMB is rendered in a digital, dot-matrix style. Each letter is composed of a grid of small squares, with some squares missing to form the shape of the letters. The 'B' and 'M' are tall, while the 'O' and 'B' are shorter.

**BOMB:** wireless battery powered output module and wireless remote indicator lamp.

The logo for ORPH is rendered in a digital, dot-matrix style. Each letter is composed of a grid of small squares, with some squares missing to form the shape of the letters. The 'O' and 'P' are tall, while the 'R' and 'H' are shorter.

**ORPH:** wireless "Orpheus" voice annunciator.

The logo for BEAC is rendered in a digital, dot-matrix style. Each letter is composed of a grid of small squares, with some squares missing to form the shape of the letters. The 'B' and 'E' are tall, while the 'A' and 'C' are shorter.

**BEAC:** wireless beacon.

The logo for EXP is rendered in a digital, dot-matrix style. Each letter is composed of a grid of small squares, with some squares missing to form the shape of the letters. The 'E' and 'P' are tall, while the 'X' is shorter.

**EXP:** "expander"; refers to the translator's wireless interface and NOT to an expander. Indicates the device type for the translator.

**APPENDIX B - LINKABLE DEVICES TO THE TRANSLATOR**

Following is a list of radio devices linkable to the translator and their corresponding display as device types and sub-menu indication.



- Wireless photo detector
- Wireless photo thermal detector
- Wireless thermal detector

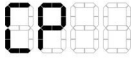

- Wireless call point

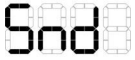

- Wireless wall sounder
- Slow whoop wireless wall sounder
- Audio-visual wireless wall sounder
- Wireless waterproof wall sounder
- Audio-visual wireless waterproof wall sounder



- Wireless supervised input module

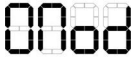

- Wireless output module



- Battery powered wireless output module
- Wireless remote indicator lamp

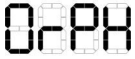

- Wireless voice annunciator



- Wireless beacon

No menu, sub-menu  
or device type

- Wireless expander

## APPENDIX C - MENU, SUB-MENU AND COMMAND STRUCTURE

The following scheme shows how the translator menu, sub-menu and command system is structured.

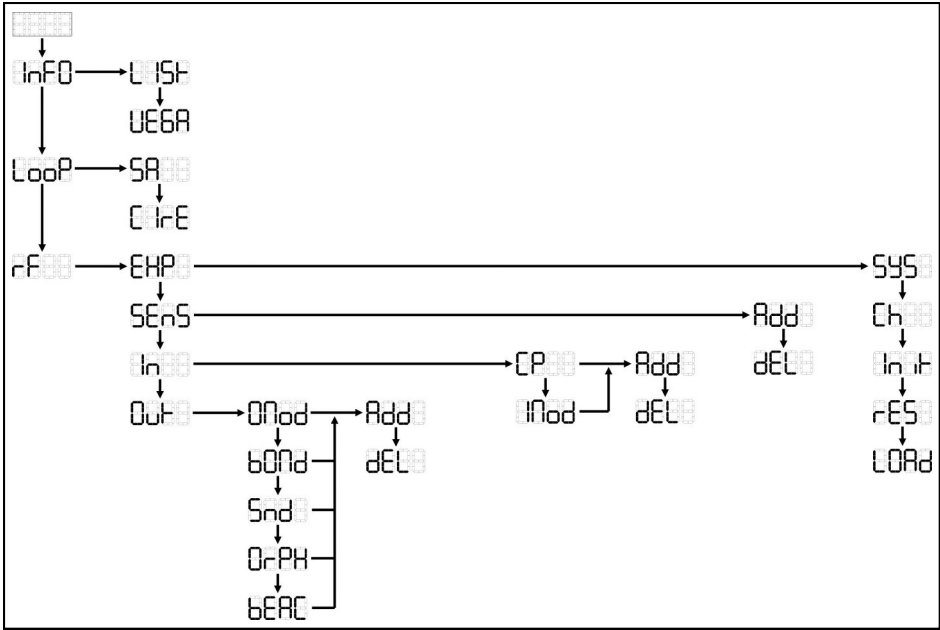

## APPENDIX D - EVENTS AND INDICATIONS TABLE LIST

Following is an events and indications table list relative to each wireless device; it summarizes the indications given by the translator through display and LED outputs. Refer to Appendix A for a list reference of the possible displayable messages. If a wireless device is connected to the translator through other expanders (operating normally), indication of events remain unaltered as summarized below; but remember that if an expander primary power supply fails, the translator loses communication with it, together with all subsequent devices in the system (see below for the indication of this particular fault); if only the expander's secondary power supply fails the expander operates normally, but this event is adequately signalled on the translator and to the control panel (see below).

### Wireless detector

Type of event	DL1	DL2	DL3	Display	Event signalled to control panel?
Missing link with the translator	-	Yes	-	Blank	Yes
Tamper fault	-	-	-	Tamper	Yes
Battery fault (primary or secondary)	-	-	Yes	Low battery	Yes
Fatal fault	-	-	-	Blank	Yes
Fire alarm (magnet test or smoke/heat alarming agent)	-	-	-	Fire	Yes

### Wireless call point

Type of event	DL1	DL2	DL3	Display	Event signalled to control panel?
Missing link with the translator	-	Yes	-	Blank	Yes
Tamper fault	-	-	-	Tamper	Yes
Battery fault (primary or secondary)	-	-	Yes	Low battery	Yes
Fatal fault	-	-	-	Blank	Yes
Fire alarm (button pressing)	-	-	-	Fire	Yes

### Wireless sounder

Type of event	DL1	DL2	DL3	Display	Event signalled to control panel?
Missing link with the translator	-	Yes	-	Blank	Yes
Tamper fault	-	-	-	Tamper	Yes
Battery fault (primary or secondary)	-	-	Yes	Low battery	Yes
Fatal fault	-	-	-	Blank	Yes

### Wireless supervised input module

Type of event	DL1	DL2	DL3	Display	Event signalled to control panel?
Missing link with the translator	-	Yes	-	Blank	Yes
Tamper fault	-	-	-	Tamper	Yes
Battery fault (primary or secondary)	-	-	Yes	Low battery	Yes
Supervision detected fault (missing load or short circuit)	-	-	-	Blank	Yes
Fatal fault	-	-	-	Blank	Yes
Fire alarm (event triggered on the input channel)	-	-	-	Fire	Yes

Wireless output module

Type of event	DL1	DL2	DL3	Display	Event signalled to control panel?
Missing link with the translator	-	Yes	-	Blank	Yes
Tamper fault	-	-	-	Tamper	Yes
Power supply fault (device switches off and misses link with the translator)	-	Yes	-	Blank	Yes
Fatal fault	-	-	-	Blank	Yes

Battery powered wireless output module and wireless remote indicator lamp

Type of event	DL1	DL2	DL3	Display	Event signalled to control panel?
Missing link with the translator	-	Yes	-	Blank	Yes
Tamper fault (tamper switch not present)	-	-	-	Blank	No
Battery fault (primary or secondary)	-	-	Yes	Low battery	Yes
Fatal fault	-	-	-	Blank	Yes

Wireless voice annunciator

Type of event	DL1	DL2	DL3	Display	Event signalled to control panel?
Missing link with the translator	-	Yes	-	Blank	Yes
Tamper fault	-	-	-	Tamper	Yes
Battery fault (primary or secondary)	-	-	Yes	Low battery	Yes
Fatal fault	-	-	-	Blank	Yes

Wireless beacon

Type of event	DL1	DL2	DL3	Display	Event signalled to control panel?
Missing link with the translator	-	Yes	-	Blank	Yes
Tamper fault	-	-	-	Tamper	Yes
Battery fault (primary or secondary)	-	-	Yes	Low battery	Yes
Fatal fault	-	-	-	Blank	Yes

Wireless expander

Type of event	DL1	DL2	DL3	Display	Event signalled to control panel?
Missing link with the translator	-	Yes	-	Blank	Yes
Tamper fault (tamper switch present but is not operative)	-	-	-	Blank	No
Power supply fault (primary)	-	Yes	-	Blank	Yes
Power supply fault (secondary)	-	Yes	-	EXP + identification n°	Yes
Fatal fault	-	-	-	Blank	Yes